

SIMULATION ANALYSIS OF LORENTZ FORCE INDUCED OSCILLATIONS IN RF CAVITIES IN VECTOR SUM AND CW OPERATION

R. Leewe*, K. Fong, TRIUMF, Vancouver, BC, Canada

Abstract

Within TRIUMF's electron LINAC, two TESLA type cavities are operated with a single klystron in CW mode. Vector sum control is applied for field stabilization and the resonance frequencies are individually tuned with a proportional feedback controller. First operational experiences showed that amplitude oscillations can start in both cavities, while the vector sum is perfectly stable. These instabilities occur at high operating fields and are driven by Lorentz force changes. This paper presents a simulation study of multiple cavities in vector sum operation with respect to Lorentz force oscillations. It will be shown that all cavities in operation have to be damped to guarantee system stability.

INTRODUCTION

Particle acceleration within TRIUMF's ARIEL facility is achieved within multiple 9 cell Tesla type cavities [1]. The cavities are operated in vector sum, instead of individual operation, for the simple reason of reducing the cost of the facility. The individual cavity pick up signals are added together and then fed into a controller, which drives an amplifier. The output signal of the amplifier is then split and fed to the individual cavities, see Fig.1. The goal of vector sum control is to achieve a stable operation field for the sum of all cavities, while individual cavities can be slightly detuned. This type of cavity operation has been proven to work well for pulsed machines [2]. There is less experience with CW operated machines using vector sum control. First operational tests of this configuration were performed at TRIUMF in July 2018. Initial tests with low gradients showed stable operation. After increasing the gradient, amplitude oscillations could be observed in both cavities with a growth time of several seconds. Fig. 2 shows an oscilloscope display, presenting the pick up signals of the two cavities. It can be observed that the amplitude oscillations are counter-phase. Hence, the vector sum is perfectly stable while both cavities ring. As these oscillations build up over several seconds this phenomenon could not be observed in pulsed machines. These oscillations are induced through the dependence between Lorentz force variations and field amplitude variations. Assuming no tuning system, if the field amplitude within the cavity changes, the Lorentz force changes which in turn affects the field amplitude again. Hence, Lorentz force and field amplitude variation behave as a closed system.

These oscillations can be a limiting factor for the operating gradient and have been analyzed for a single cavity without a tuning system in [3]. [3] provides an understanding how

the cavity walls move and what are the conditions for these oscillations to occur. The conditions can be summarized as a high electric field (10MV/m), CW operation, vector sum control opposed to individually controlled, and that the driven frequency must be higher than the electric field.

This paper aims to provide a better understanding how multiple cavities behave in vector sum and CW operation. It is built up on [3].

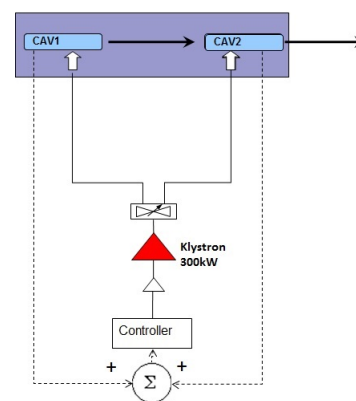

Figure 1: Block diagram: 2 cavities are driven by a single klystron in vector sum control.



Figure 2: Experimental results: Pick-up signals of 2 cavities in vector sum control after several seconds of operation. Mechanical resonance frequency is roughly 160 Hz and the RF bandwidth is roughly 300 Hz.

SYSTEM DESCRIPTION

The cavity wall movement driven by Lorentz force variation can be mathematically modelled as

$$\ddot{x} + \epsilon \dot{x} + \Omega^2 x = -\Lambda(v^2 - v_0^2), \quad (1)$$

* ramona@triumf.ca

where Λ denotes the Lorentz constant, v the actual cavity voltage and v_0 the initial voltage, x the wall position, ϵ the damping coefficient, and Ω the mechanical resonance frequency. A derivation of the electrical signal as well as a stability analysis of the combined system has been shown in [3].

Additionally, it has been shown that the system has a stable and unstable regions. For ω , the natural resonance frequency of the cavity, smaller ω_0 , operating frequency, is the equilibrium point stable, while for $\omega > \omega_0$ is the system unstable. The phase space plot for both conditions is shown in Fig. 3. For the stable case it can be observed that for two different initial conditions the system states spiral to its equilibrium point. For the unstable case it can be observed that the system behaves different for different initial conditions. If the initial conditions are within the limit cycle they spiral outwards and inwards for the other case. An analysis of this phenomenon has been presented in [3].

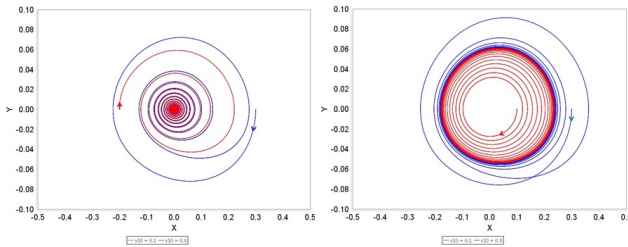

Figure 3: Phase space simulation results for $\omega_0 > \omega$ (left) and $\omega_0 < \omega$ (right) and different initial conditions. $\Omega = 1$.

SIMULATION ANALYSIS

Within this section we want analyze two cavities in vector sum operation. In particular, it is of interest whether both cavities have to be actively damped to guarantee stable system operation. The vector sum is controlled by a proportional controller.

The state equations for numerical simulations are derived from equation (1) and are given by

$$\begin{aligned}
 \dot{x}_1 &= y_1 \\
 \dot{y}_1 &= -\epsilon_1 y_1 - \Omega^2 x_1 - \Lambda (v_{i1}^2 + v_{q1}^2 - v_0^2) \\
 \dot{v}_{i1} &= \bar{\omega} (-v_{i1} - (a_1 + x_1) v_{q1} + v_{fi1}) \\
 \dot{v}_{q1} &= \bar{\omega} ((a_1 + x_1) v_{i1} - v_{q1} + v_{fq1}) \\
 \dot{x}_2 &= y_2 \\
 \dot{y}_2 &= -\epsilon_2 y_2 - \Omega^2 x_2 - \Lambda (v_{i2}^2 + v_{q2}^2 - v_0^2) \\
 \dot{v}_{i2} &= \bar{\omega} (-v_{i2} - (a_2 + x_2) v_{q2} + v_{fi2}) \\
 \dot{v}_{q2} &= \bar{\omega} ((a_2 + x_2) v_{i2} - v_{q2} + v_{fq2}) \\
 v_{fi1} &= v_{i1} + K_p ((v_{i1} + v_{i2}) / 2 - v_{iref}) \\
 v_{fq1} &= v_{q1} + K_p ((v_{q1} + v_{q2}) / 2 - v_{qref}) \\
 v_{fi2} &= v_{i2} + K_p ((v_{i1} + v_{i2}) / 2 - v_{iref}) \\
 v_{fq2} &= v_{q2} + K_p ((v_{q1} + v_{q2}) / 2 - v_{qref})
 \end{aligned} \tag{2}$$

where the indices 1,2 represent cavity 1 and 2, respectively. $a = \frac{\omega_0 - \omega}{\bar{\omega}}$, where $\bar{\omega}$ represents the ratio of the RF bandwidth over the mechanical resonance. The initial voltage condition is given by

$$v_0^2 = \left(\frac{1}{1+a} \right) v_q^2. \tag{3}$$

$v_{fi1,2}$ and $v_{fq1,2}$ are the feedback voltages. \dot{v}_i and \dot{v}_q are obtained from the differential equation describing the field within the cavity [3] and $v = v_i + jv_q$.

Simulation of 2 Cavities in Vector Sum Control

Section showed that oscillations will be excited or damped depending on the sign of a , Fig. 3. To get an understanding when the oscillations are excited in two cavities in vector sum all possible parameter combinations have been simulated. The variable parameters are

- $a_{1,2}$ - the initial misalignment of both cavities
- $c_{1,2}$ - individual cavity damping (which could be realized through piezo feedback)
- $x_{1,2}$ - initial condition of each cavity

Choosing the three categories

1. $a_1 > 0$ and $a_2 > 0$, both cavities are individually stable
2. $a_1 < 0$ and $a_2 > 0$, 1 cavity unstable the second is stable on their own
3. $a_1 < 0$ and $a_2 < 0$, both cavities are individually unstable

then we have the different parameter options of no damping, one cavity damped, both cavities damped for the two cases of either cavity 1 or cavity 2 having an initial condition $x \neq 0$. As it is not necessary to plot each parameter combination we include only the necessary Figures which lead to the conclusion.

The next Figures show the individual cavity wall positions, the individual voltage amplitudes and the voltage vector sum of the 2 cavities in vector sum operation, under different conditions. Note, the voltages have been normalized.

Starting with the first category $a_1 > 0$ and $a_2 > 0$, both cavities operating on the stable side but both are undamped, Fig. 4. As expected, the simulation result shows stable system operation although cavity 1 induces initially an oscillation in cavity 2. The voltages are stable, but the mechanical oscillations settle into a stable, in-phase oscillation since they are undamped. Hence, if it can be guaranteed, that the misalignment is always positive, stable system operation is guaranteed.

With respect to the second case $a_1 < 0$ and $a_2 > 0$, Fig. 5 shows the result for the same parameter configuration regarding damping and initial conditions as the previous case. It can be observed that cavity 1, which operates on the unstable side induces instabilities in cavity 2 (operating on the stable

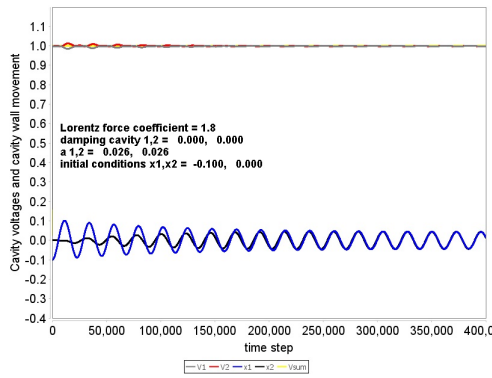

Figure 4: Cavity wall positions and voltages and vector sum versus time of 2 undamped cavities in vector sum operation. $a_1, a_2 > 0$

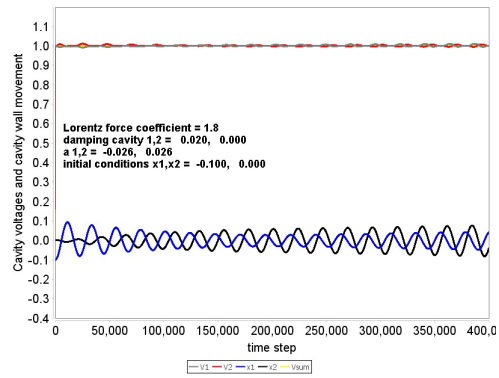

Figure 6: Cavity wall positions (x_1, x_2), voltages (V_1, V_2) and vector sum (V_{sum}) versus time. Cavity 1 is damped.

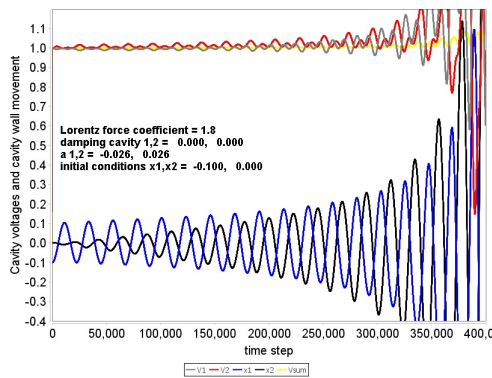

Figure 5: Cavity wall positions and voltages and vector sum versus time of 2 undamped cavities in vector sum operation. $a_1 < 0, a_2 > 0$

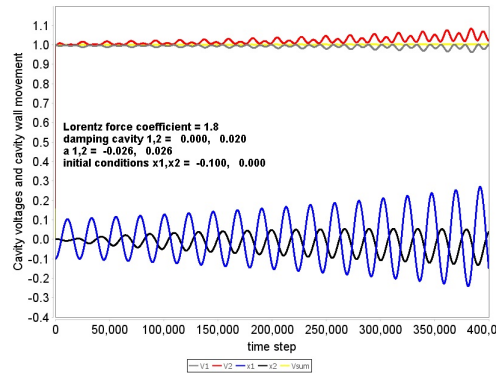

Figure 7: Cavity wall positions (x_1, x_2), voltages (V_1, V_2) and vector sum (V_{sum}) versus time. Cavity 2 is damped.

Simulation of 4 Cavities in Vector Sum Control

To verify whether the result that all cavities in operation have to be damped to guarantee stability is valid for more than 2 cavities, the same systematic simulation analysis has been performed with 4 cavities in vector sum operation. As the results agree with the previous analysis only 2 simulation cases are plotted below. In particular, we focus on the stability independent of the initial misalignment a . Fig. 9

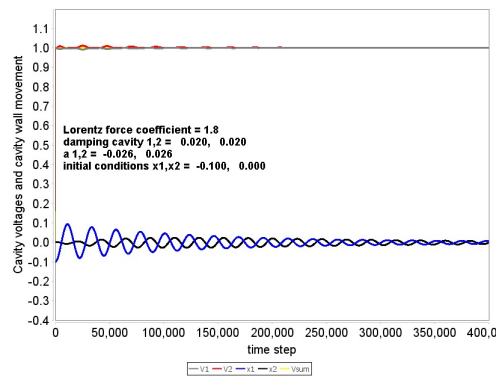

Figure 8: Cavity wall positions (x_1, x_2), voltages (V_1, V_2) and vector sum (V_{sum}) versus time. Both cavities are damped.

Content from this work may be used under the terms of the CC BY 3.0 licence (© 2019). Any distribution of this work must maintain attribution to the author(s), title of the work, publisher, and DOI.

side). Further it can be observed that the two mechanical oscillations are growing and are out of phase, which keeps the vector sum voltage stable. This leads to the conclusion that at least 1 cavity has to be damped through active feedback if stable system operation has to be guaranteed independent of the initial misalignment a .

Adding a damping constant ϵ to the system, to simulate perfect active feedback. Fig. 6, Fig. 7, and Fig. 8 show the results for only cavity 1 damped, only cavity 2 damped, and both cavities damped, respectively. The initial misalignment is kept at $a_1 < 0$ and $a_2 > 0$. Looking at Fig. 6 and 7 it is shown that independent of which cavity is damped, both cavities become unstable. Further, Fig. 7 shows how vector sum and CW operation are the main sources of this instability, as it can be observed that the vector sum voltage stays at its desired value while both individual cavity voltages are oscillating counter phase as it has been observed in TRIUMF's acceleration cryomodule, Fig. 2. Finally, Fig. 8 shows stable system operation when both cavities are damped, this has been confirmed for $a_1 < 0$ and $a_2 < 0$.

shows the case where three cavities are damped. It can be observed that the undamped cavity with a negative initial misalignment starts oscillating and going into limit cycle as shown in Fig. 3. Note that we changed the simulation time step from $T_s = 0.001$ to $T_s = 0.005$ to show the limit cycle existence in multiple cavities in vector sum operation. Fig. 10 shows stable operation when all cavities are damped.

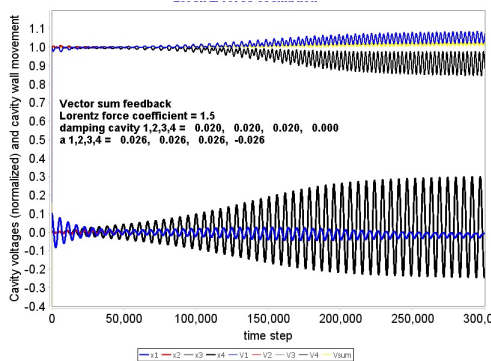

Figure 9: Cavity wall positions (x_1 , x_2 , x_3 , x_4), voltages (V_1 , V_2 , V_3 , V_4) and vector sum (V_{sum}) versus time. Three cavities are damped.

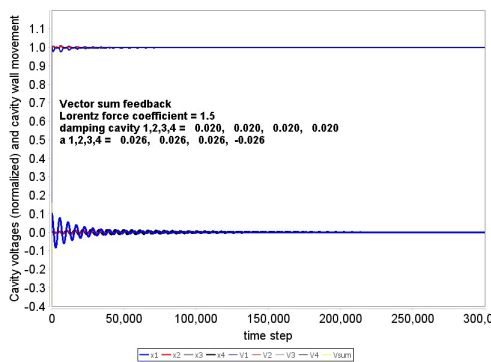

Figure 10: Cavity wall positions (x_1 , x_2 , x_3 , x_4), voltages (V_1 , V_2 , V_3 , V_4) and vector sum (V_{sum}) versus time. All cavities are damped.

CONCLUSION

This paper presented a simulation analysis of Lorentz force induced oscillation of 2 cavities in vector sum and CW operation. It was shown that an unstable cavity can drive a stable cavity unstable. It can be concluded that all cavities in vector sum and CW operation have to be damped to guarantee system stability independent of any individual cavity misalignment a .

REFERENCES

- [1] V. Zvyagintsev *et al.*, “Nine-cell Elliptical Cavity Development at TRIUMF”, in *Proc. SRF’11*, Chicago, IL, USA, Jul. 2011, paper MOPO020, pp. 107–109.
- [2] T. Schilcher, “Vector Sum Control of Pulsed Accelerating Fields in Lorentz Force Detuned Superconducting Cavities”, Ph.D. thesis, Department of Physics, University of Hamburg, 1998.
- [3] K. Fong and R. Leewe, “Parametric Pumped Oscillation by Lorentz Force in Superconducting Rf Cavity”, presented at the IPAC’19, Melbourne, Australia, May 2019, paper WEPB003.